

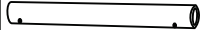

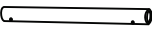





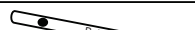

Goal Locking (6'x4')

COMPONENT CHECKLIST AND ASSEMBLY INSTRUCTIONS

COMPONENT	NO.	QTY.
	1	2
	2	4
	3	2
	4	2
	5	2
	6	4
	7	2
	8	2
	9	2
 U BAND	10	2
NET	11	1
 NET CLIPS	23	1 bag

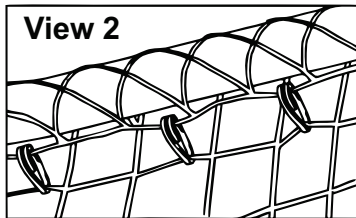
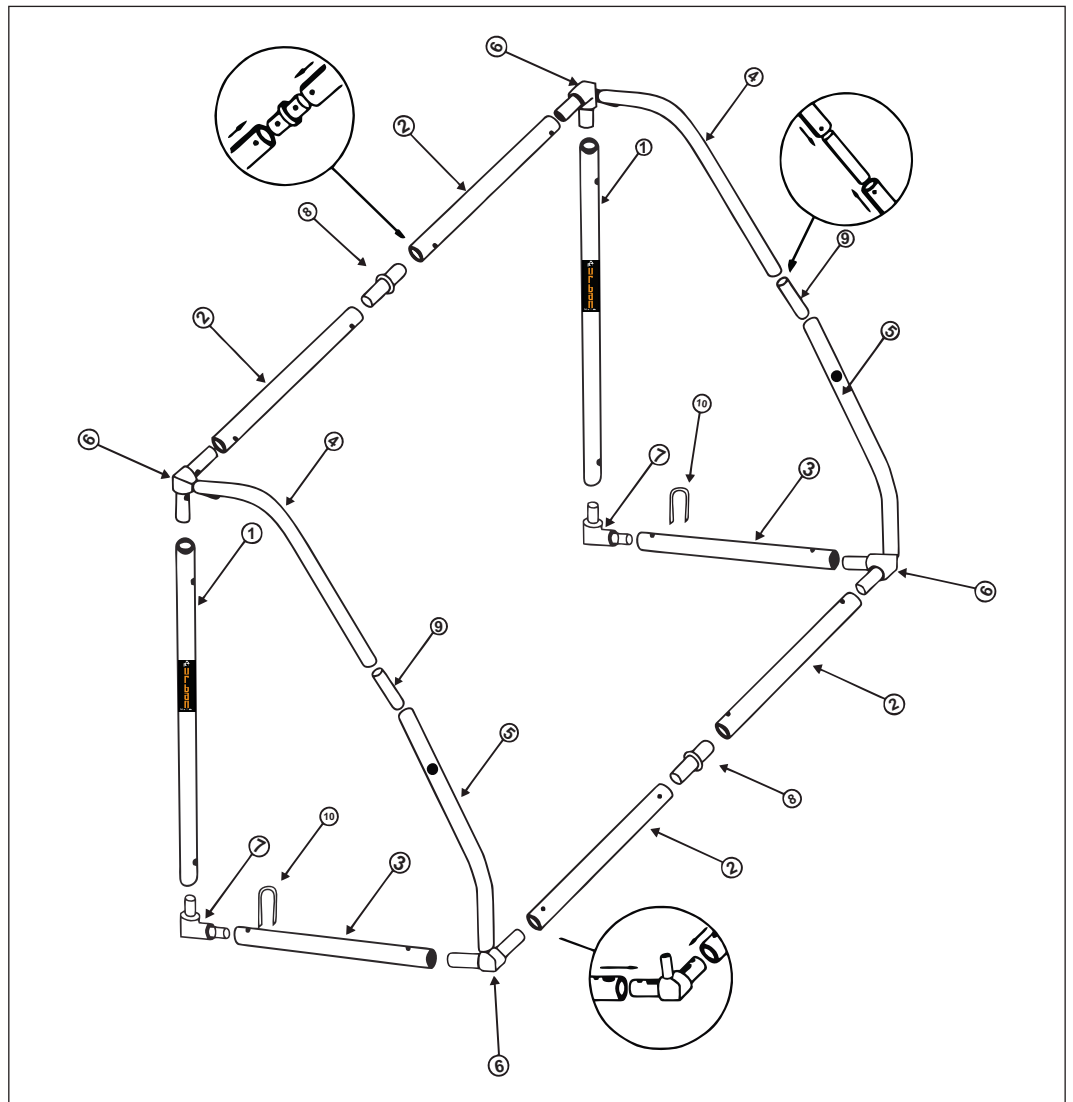

SAFETY INSTRUCTIONS

1. Always check the goal post and net for defects before use and replace damaged parts.
2. Do not use goal with faulty parts.
3. The goal must always be secured to the ground. Weight to be used on hard surface, ground anchors on grass.
4. Never climb on the or the goal frame.
5. The goal must never be used without the net fitted.

Please adhere to the safety instruction at all times.

ASSEMBLY INSTRUCTIONS

1. Assemble the base first.
2. Assemble the cross bar and uprights.
3. Fit the cross bar and upright assembly to the base.
4. Assemble the tension bar items 8 & 9 together.
5. Fit the tension bar assemblies to the goal. It is important that the tension bar is fitted into the bottom of the goal first, then bolt them to the upper frame.
6. Fit the net by wrapping the net round the post and clipping on the inside. Colored cord denotes top of the net.
7. Ensure the posts are upright and the cross bar is level before securing to the ground with the anchors.

INFORMATION

1. When the goal is not being used, dismantle and store in a secure area.
2. Not suitable for children under age of 3 years due to small parts i.e. quick clips and length of cord.
3. It is recommended that the goal is assembled by an adult.